

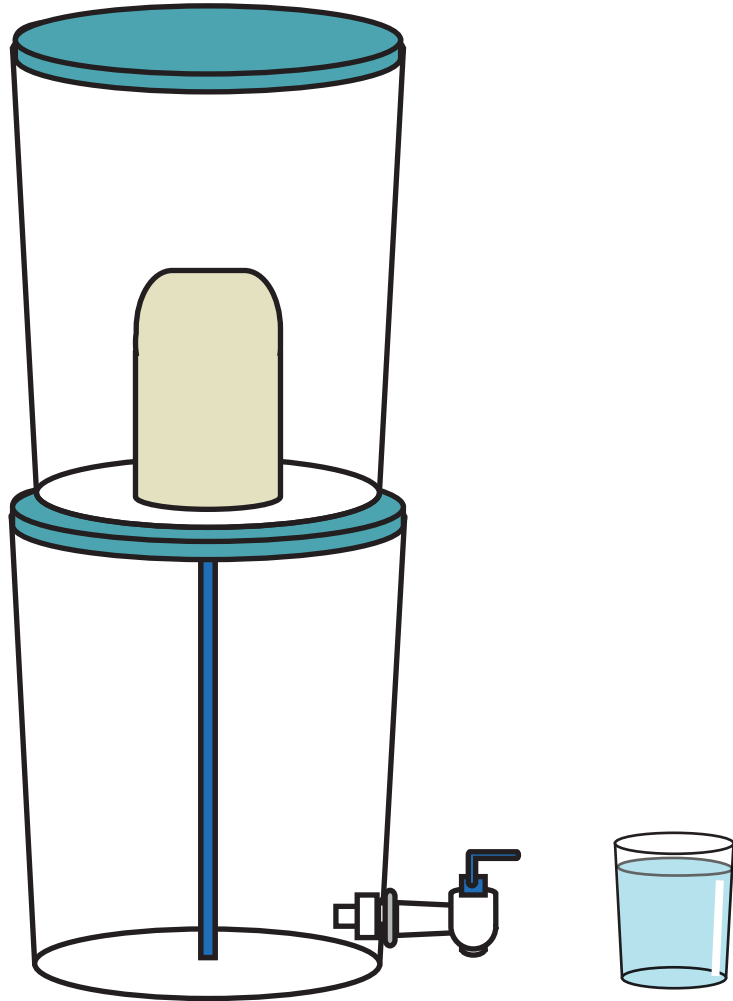

Tulip Table Top Water Filter Manual



SAFE WATER, GOOD LIFE

Components

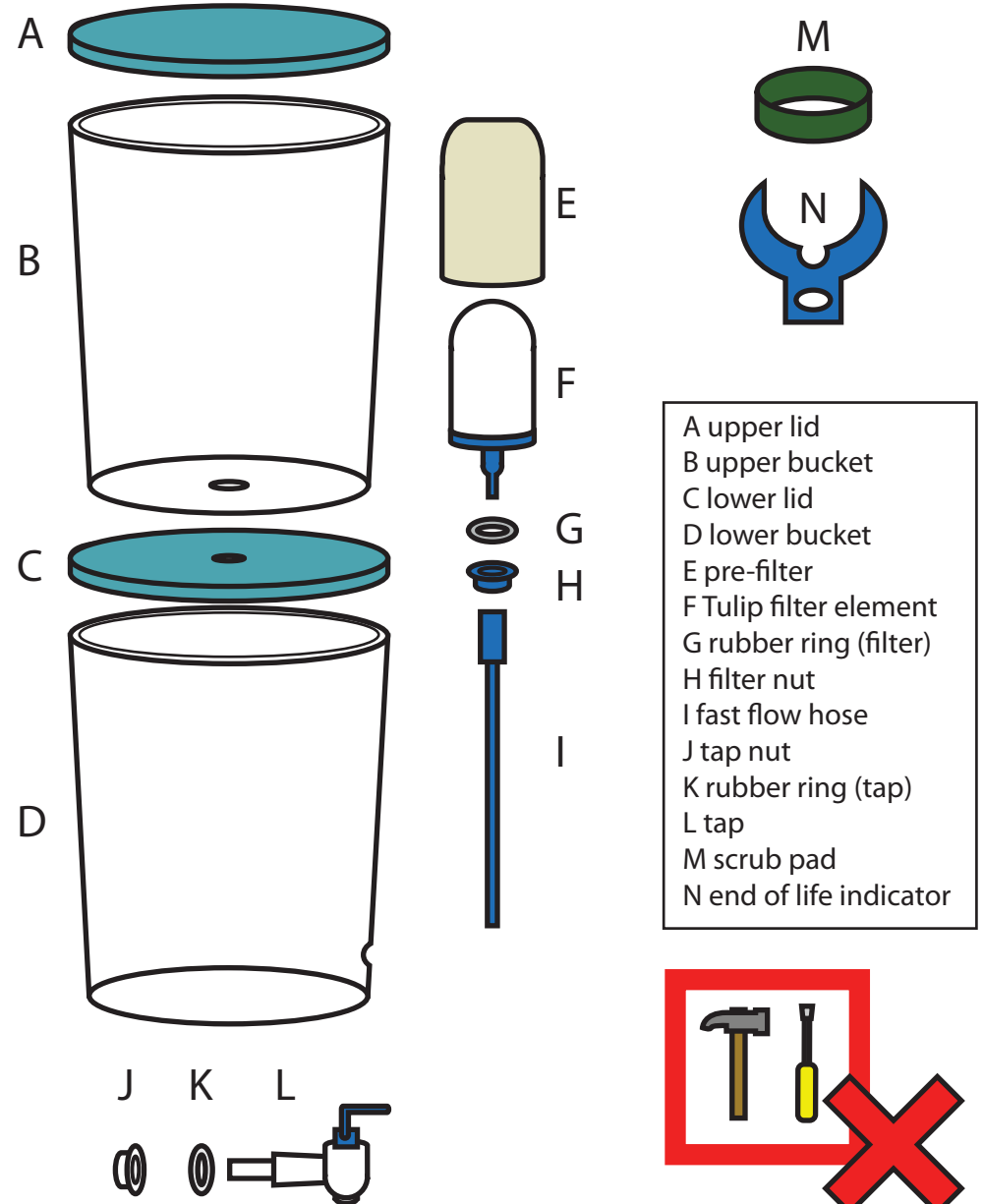

No tools needed!

1

Assembling the Tulip Table top

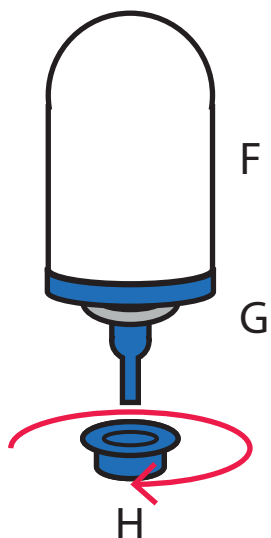

Remove the filter nut (H) from the Tulip filter element (F).

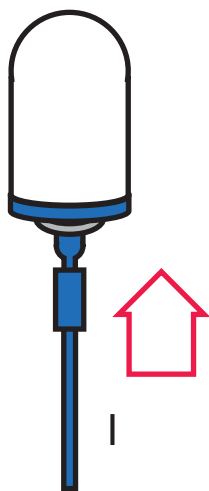
2

Attach the fast flow hose (I) to the nipple of the Tulip filter element (F) and make sure it is tightly fastened.

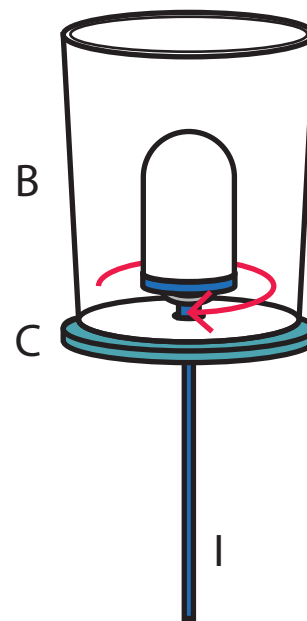
3

Don't push the filter element, but turn it to avoid breakages and ensure tight fastening.

Screw the Tulip filter element (F) with the rubber ring (G) and the fast flow hose (I) into the upper bucket (B) and lower lid (C). Make sure the rubber ring (G) is between the filter element (F) and the bottom of the bucket.

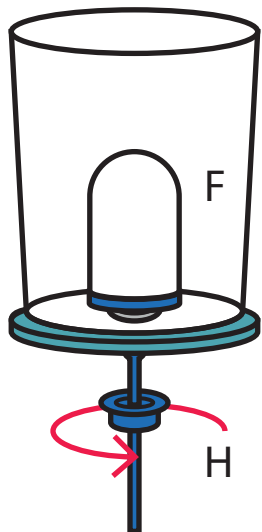
4

Fasten the Tulip filter element (F) by using the filter nut (H).

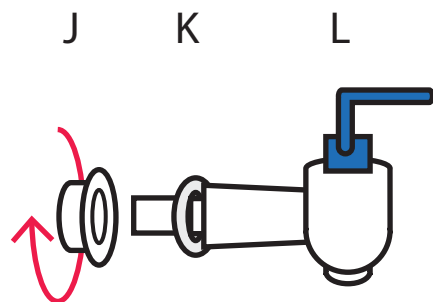
5

Unscrew the tap nut. Leave the rubber ring (K) on the tap (L).

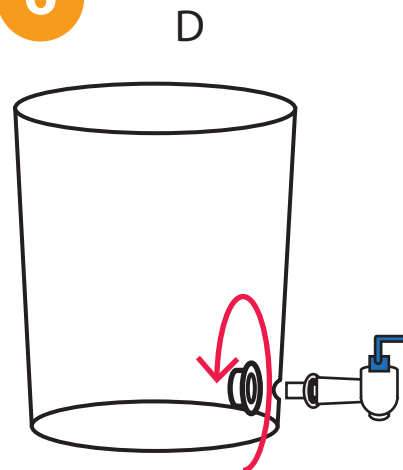
6

Screw the tap with rubber ring through the hole on the side of the lower bucket (D). Fasten the tap tightly by using the tap nut (J).

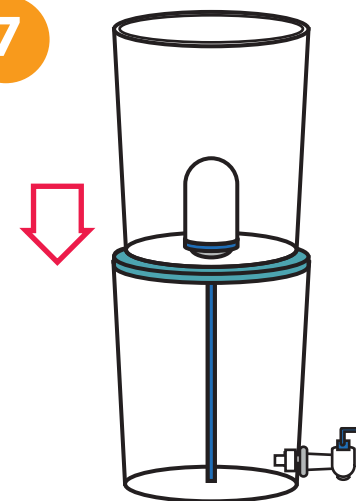
7

Place the upper bucket, with the lid of the lower bucket, Tulip filter element and fast flow hose onto the lower bucket.

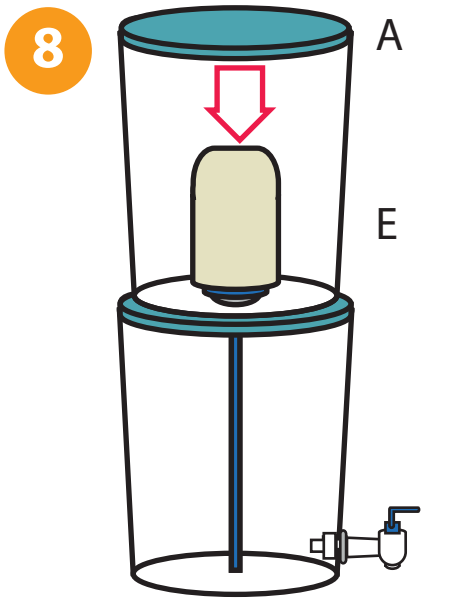

Put the pre-filter (E) over the filter element and place the upper lid (A).

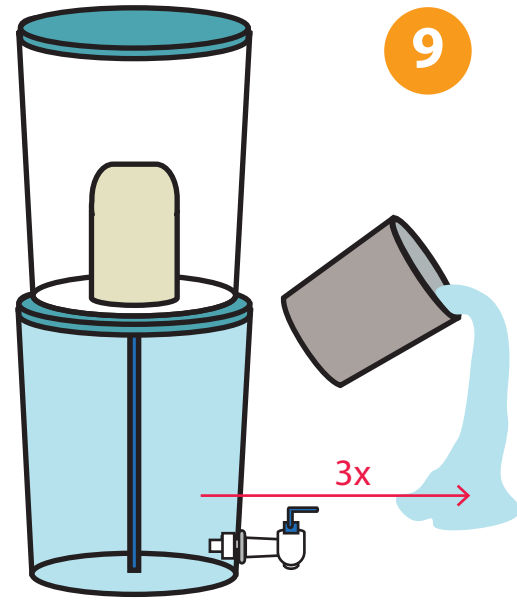

The first 30 liters (3 full buckets) of filtered water have to be thrown away.

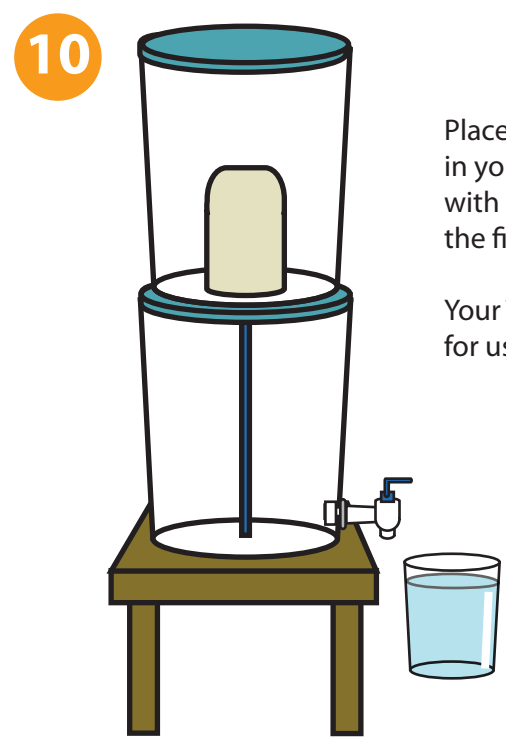

Place the filter at a safe, convenient place in your house. Make sure children won't play with the filter and handle it carefully, otherwise the filter might break.

Your Tulip Table Top water filter is now ready for use.

How does it work?

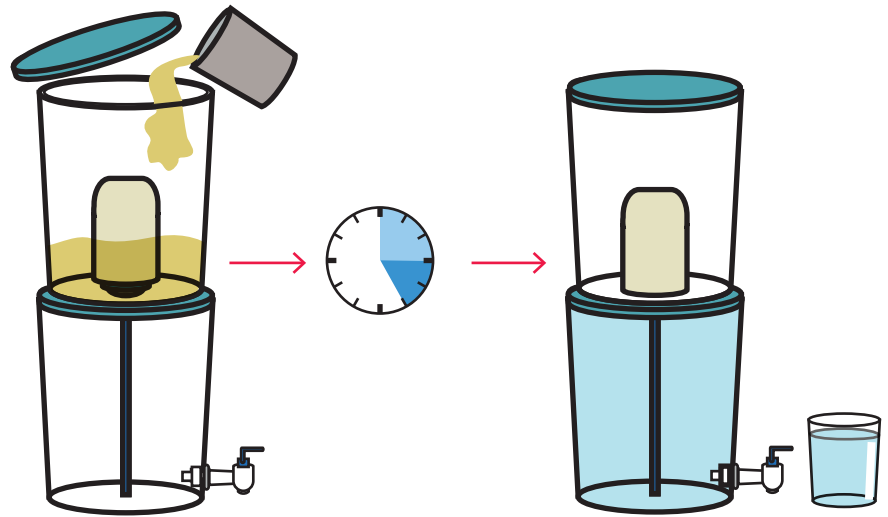

Pour dirty water into the top container. The filter takes 3-5 hours to clean one whole bucket of dirty water. Safe water is stored in the bottom container. Water is safe to drink from the tap.

Maintenance

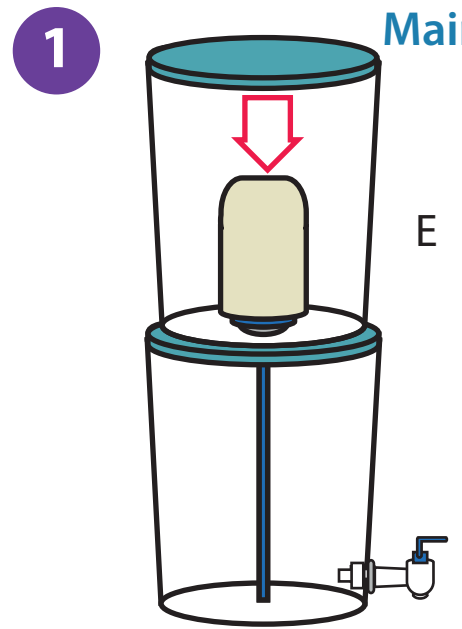

To protect the filter element against clogging, the filter element is covered with a washable pre-filter (E).

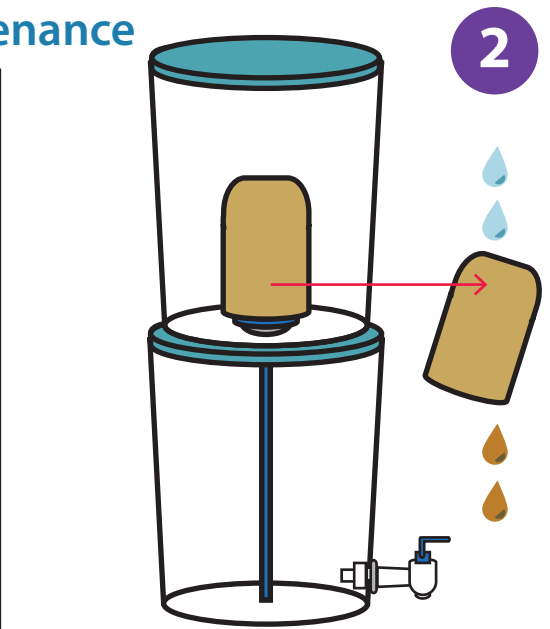

When the pre-filter becomes dirty, remove the pre-filter from the ceramic element and wash it in clean water.

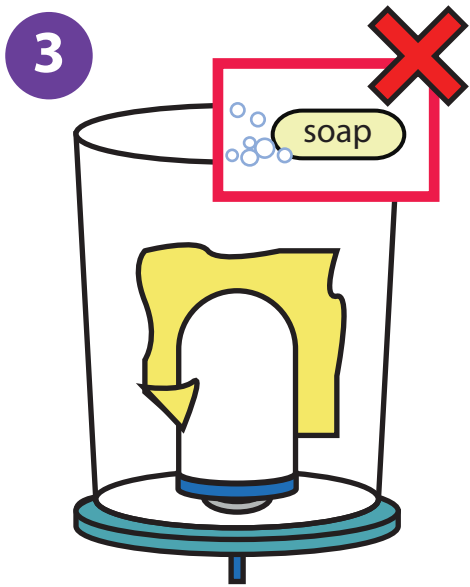

Wash the filter element (F) regularly with a cloth or toothbrush. Do not use soap!

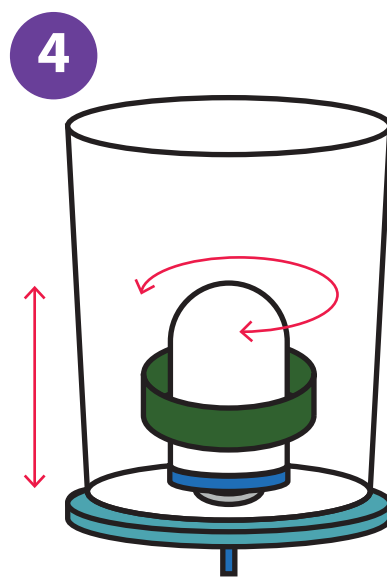

After some time, the flow rate reduces. Take the scrub pad (M) and carefully scrub the filter element to remove a very small layer of the ceramic material.

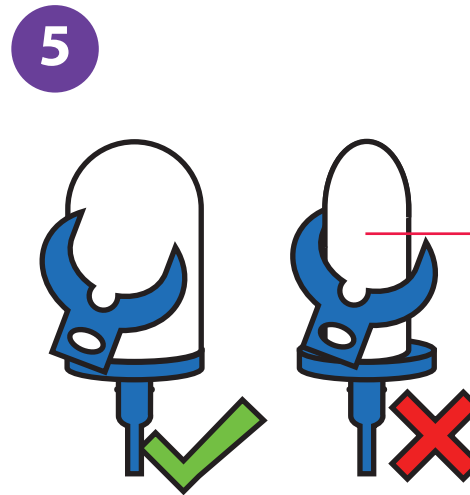

With the plastic end of life indicator (N) you can measure when your filter element has to be replaced. When the end of life indicator (N) fits around the thinnest part of the filter, the filter is no longer able to make the water safe and must be replaced.

1 Replacing the filter element

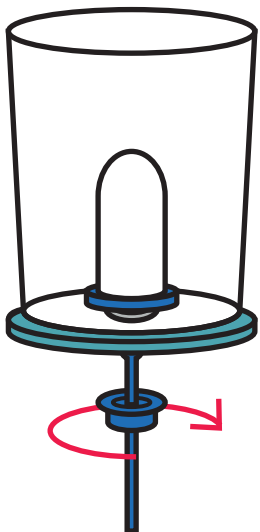

Unscrew the filter nut (H).

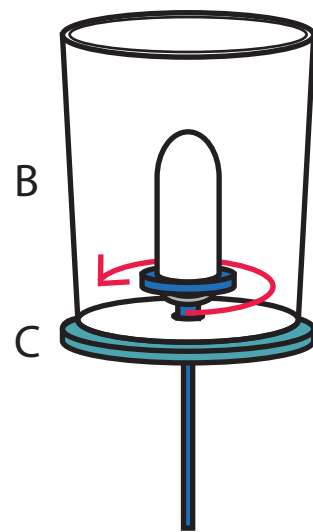

Unscrew the ceramic candle carefully.

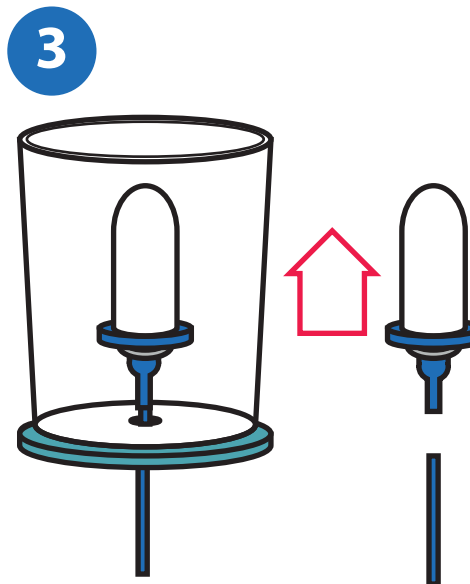

Take out the ceramic candle element. Pull the fast flow hose (I) off the filter element.

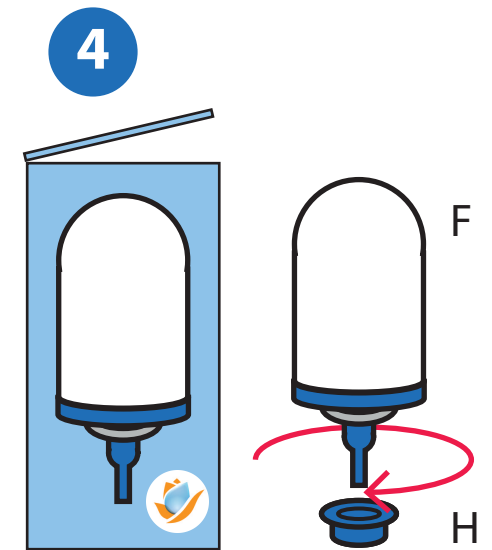

Take a new filter element out of the box. Remove the filter nut (H) from the Tulip filter element (F).

5

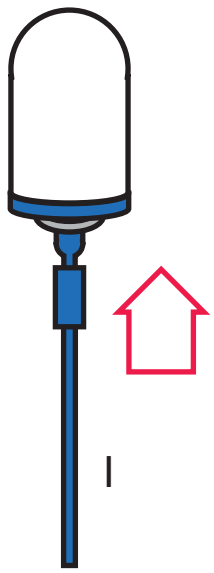

Attach the fast flow hose (I) to the nipple of the Tulip filter element (F) and make sure it is tightly fastened.

6

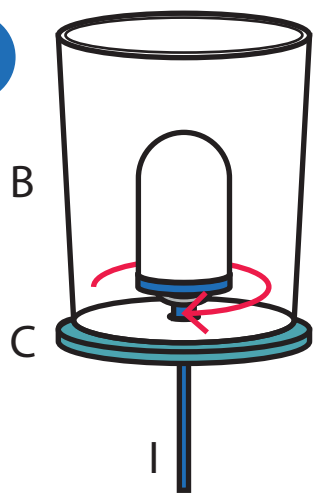

Screw the Tulip filter element (F) with the rubber ring (G) and the fast flow hose (I) into the upper bucket (B) and lower lid (C). Make sure the rubber ring is between the filter element (F) and the bottom of the bucket.

7

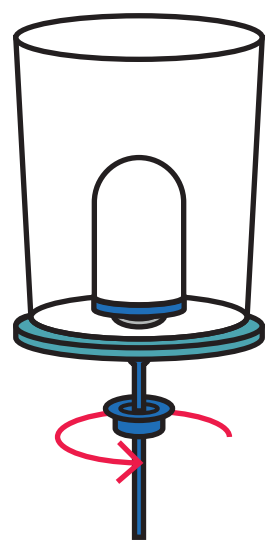

Fasten the Tulip filter element (F) by using the filter nut (H).

8

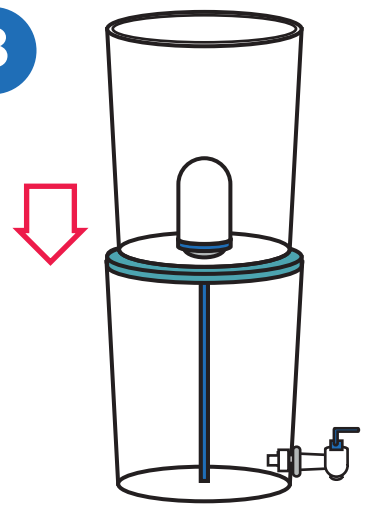

Place the upper bucket, with the lid of the lower bucket, Tulip filter element and fast flow hose onto the lower bucket.

9

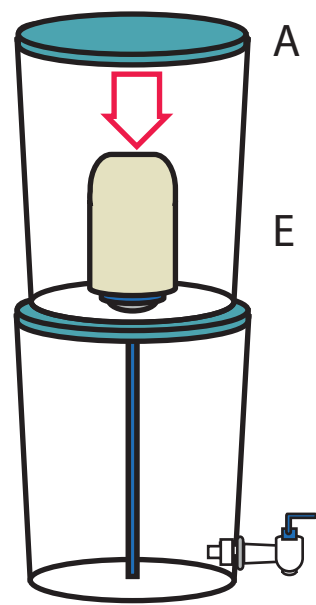

Put the pre-filter (E) over the filter element and place the upper lid (A).

10

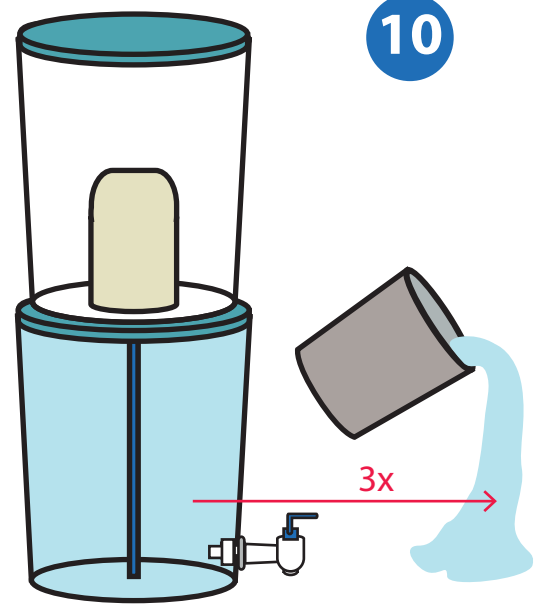

The first 30 liters (3 full buckets) of filtered water have to be thrown away.

11

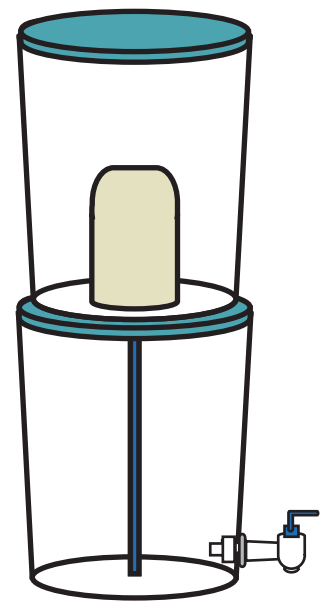

Your Tulip table top water filter is now ready for use again.



 **Crystal Clear**

 **Good Taste**

 **Safe**

Crystal clear water that is better tasting and less expensive as compared to boiled water. Safe drinking water from the Tulip Table Top water filter will help to prevent diseases like:

- Diarrhea
- Cholera
- Parasites
- And other waterborne diseases

For questions or replacement filters
please contact your local supplier.

